



# Creative Retail Lighting

CREATIVE RETAIL LIGHTING  
54 TALL PINES ROAD  
WITHAM ST HUGHS  
LINCOLN  
LN6 9RT

TEL: 08455 444882  
sales@creativeretailighting.co.uk  
www.createretailighting.co.uk

---

## Plug & Play LED lighting system

---

Introducing a unique plug and play bespoke LED lighting system specifically designed for retail display applications.



This system offers an extremely high level of flexibility together with high quality components and construction to make installation simple.

Plug & Play enables quick and easy installation reducing manufacturing costs significantly.

All lighting products are fully interchangeable using a user friendly connection system. With an extensive range of interconnect cables, splitters and distribution box's it allows users to easily build their own lighting solution to fit the end product without fuss.

For more information contact Creative Retail Lighting on

TEL: 08455 444882

Email: sales@creativeretailighting.co.uk

---

## Plug and Play Cable System

---



- ◆ Simple and easy to use push-fit connection system
- ◆ Male & Female Connectors to ensure correct fitting
- ◆ Supplied pre-fitted to lighting products as required
- ◆ Able to handle up to 7 amps per connector
- ◆ All cable conforms to low smoke & fume regulations below.
- ◆ IEC 60332-1-2 Flame Resistance
- ◆ IEC 60332-3-24 Fire Resistance
- ◆ Re enforced cable soldering giving a more robust connection

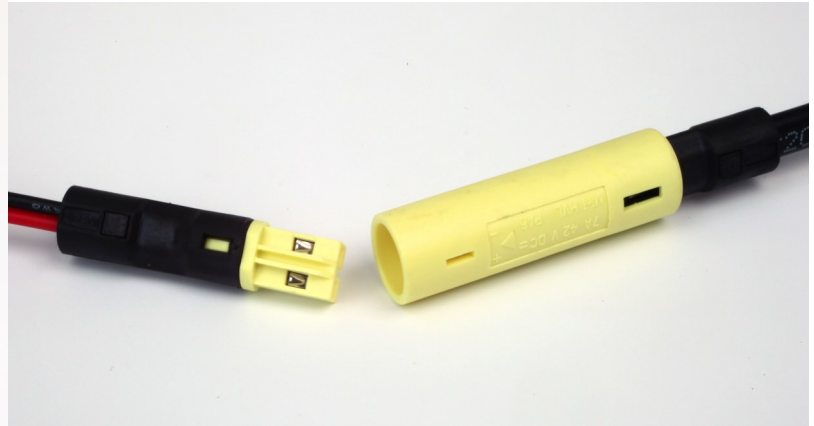
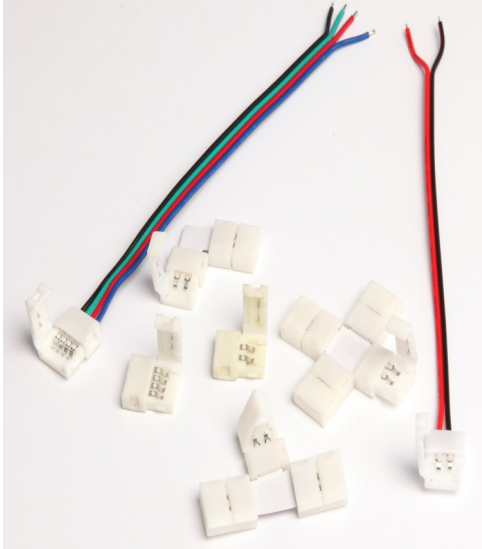

---

## Flexible LED Strip

---



- ◆ Available in lengths from 50mm to 5 meters,
- ◆ Cuts possible in 50mm length graduations—don't pay for more than you need.
- ◆ Available in 3 colour temperatures
  - ◆ Warm light (3000k)
  - ◆ Day light (4000k)
  - ◆ Cool light (6000k)
- ◆ 3 strip types available
  - ◆ 3528 60 LED per meter
  - ◆ 3528 120 LED per meter
  - ◆ 5050 60 LED per meter
- ◆ 40000 Hr LED Life, equivalent to over 10 years at 8 hours per day
- ◆ Strip supplied with self adhesive backing tape ready for direct installation where required.
- ◆ Supplied with 1 year guarantee

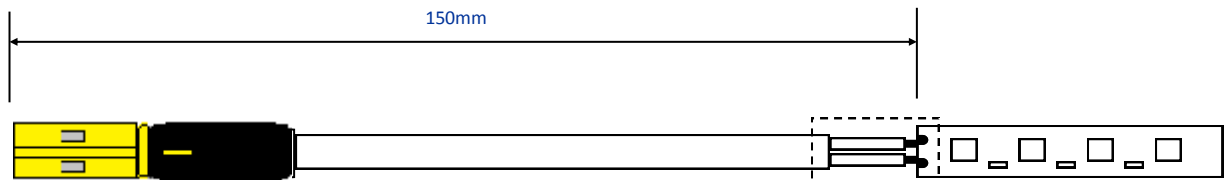

## Drivers



- ◆ Open frame driver modules ideal for installation in enclosed areas where heat dissipation is a potential problem
- ◆ Double Insulated drivers for installations where open frame may not be an option due to regulations
- ◆ Various wattages available from 12w to 300w
- ◆ 12V DC Output, 2 channel output on higher wattage models
- ◆ Pre-fitted with distribution box or single output cable ready for direct plug and play connection to lighting products.
- ◆ 240v input
- ◆ Pre-fitted with UK mains cable—various length options available

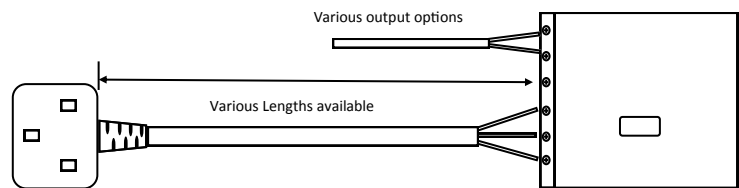

## Single Output Cable



- ◆ Supplied pre-connected to driver module and ready to connect directly to LED lighting products.
- ◆ Terminated with female connector
- ◆ Supplied 150mm long
- ◆ Maximum of 7 amps per cable

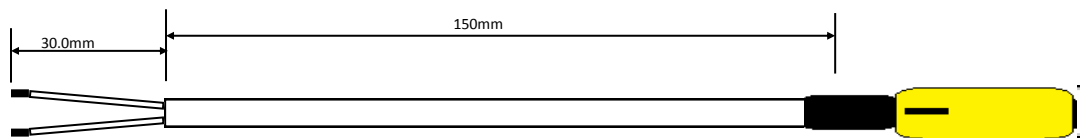

## Distribution Box



- ◆ Supplied pre-connected to driver module and ready to connect directly to lighting products
- ◆ Enables the connection of multiple LED lighting products to single driver.
- ◆ Can be secured using screw holes moulded into the box
- ◆ 6 Output Distribution Box
- ◆ Maximum of 10 amps per distribution box

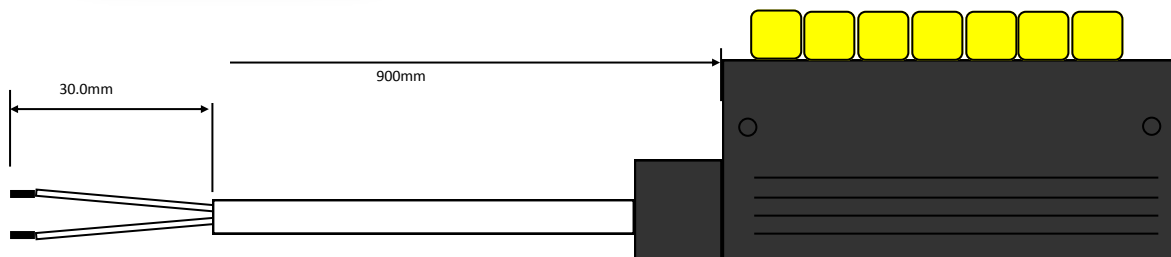

---

## "Y" Splitter

---



- ◆ Enables connection of two lighting products to single source
- ◆ Rated at 7 amps
- ◆ Can be used in a variety of instances.
- ◆ Small and easy to use

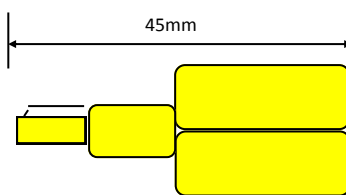

---

## Extension Cables

---



- ◆ Allows lighting products to be placed further away from power source.
- ◆ Lots of length options available from 150mm to 5m
- ◆ All cable conform to low smoke & fume regulations
- ◆ Terminated with 1 male connector and 1 female connector
- ◆ Long lengths supplied wrapped to avoid tangling and aid easy installation.

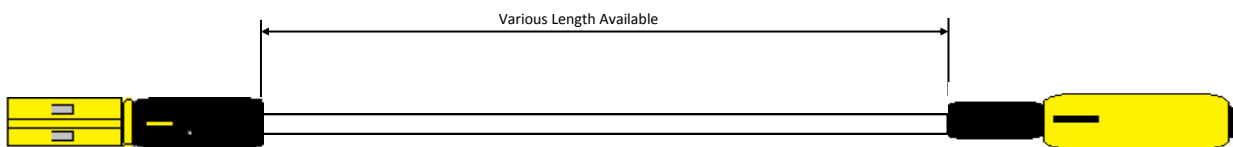

---

## 3 / 5 Way Spider

---



- ◆ Enables multiple lighting products to be powered from a single cable.
- ◆ Terminated with 1 male connector and 1 female connector
- ◆ 3 way spider is 1M long with 3 outputs
- ◆ 5 way spider is 2M long with 5 outputs
- ◆ Each connection is rated at 7 amps

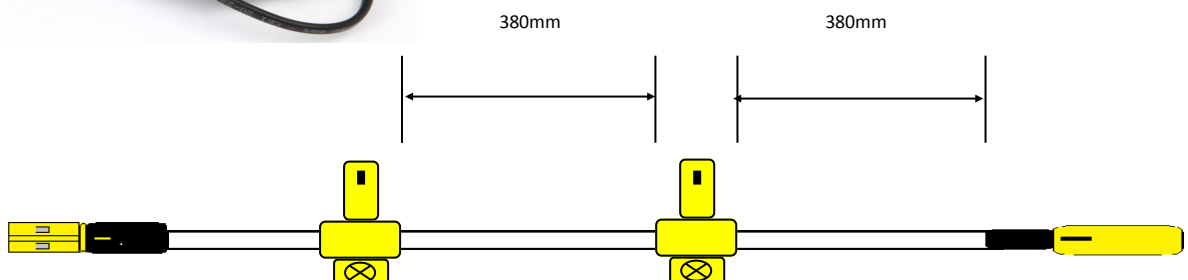

---

## LED Strip Joint Cable

---



- ◆ Enables two LED strip products to be permanently connected together.
- ◆ Supplied pre-fitted to multiple LED strip lengths of your choice
- ◆ Available in several length options, 150mm, 300mm and 500mm
- ◆ All soldered joints are reinforced to prevent loose connections

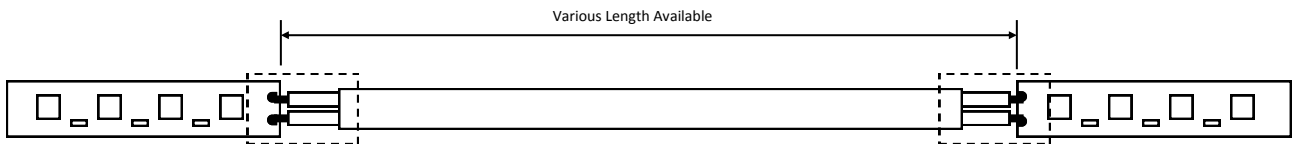

---

## LED Strip Joint Cable with Break Connector

---



- ◆ Enables two LED strip products to be connected together
- ◆ Fitted with Microfit connector system to enable strips to be disconnected as required.
- ◆ Supplied pre-fitted to multiple LED strip lengths of your choice
- ◆ Available in several length options, 150mm, 300mm and 500mm

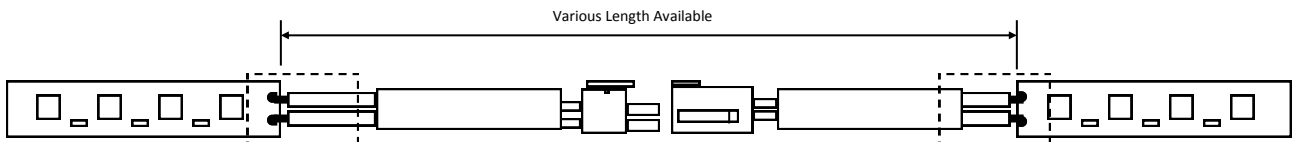

---

## LED 8mm Snap Connector & Plug

---



- ◆ Can be used to connect 8mm LED ribbon without the use of soldering
- ◆ Terminated with a male plug in order to fit the plug & play system
- ◆ Available with 120mm or 500mm tail
- ◆ Able to handle up to 5 amps per connector

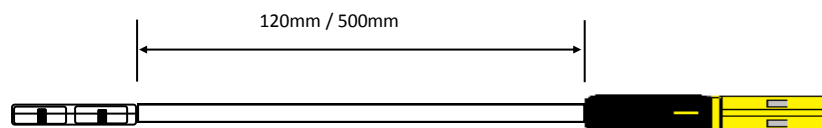



---

## 8mm Snap Connector - LED to LED

---



- ◆ Just simply insert the LED under the contacts and close the lid
- ◆ Enables two LED strip products to be connected together in a straight line.
- ◆ Able to handle up to 5 amps per connector
- ◆ Can be used with 60 LED's per meter

---

## 8mm Snap Connector - "L" Shape

---

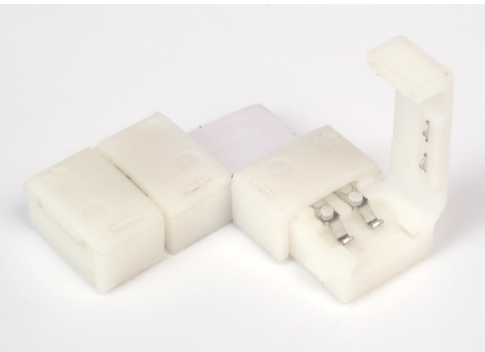

- ◆ Just simply insert the LED under the contacts and close the lid
- ◆ Enables two LED strips to be connected together at 90 degrees
- ◆ Able to handle up to 5 amps per connector
- ◆ Can be used with 60 LED's per meter

---

## 8mm Snap Connector - "T" Shape

---



- ◆ Just simply insert the LED under the contacts and close the lid
- ◆ Enables three LED strips to be connected together at 90 degrees or a "T" junction
- ◆ Able to handle up to 5 amps per connector
- ◆ Can be used with 60 LED's per meter

---

## 8mm Snap Connector - "+" Shape

---



- ◆ Just simply insert the LED under the contacts and close the lid
- ◆ Enables four LED strips to be connected together at 90 degrees, "T" junction or a cross formation
- ◆ Able to handle up to 5 amps per connector
- ◆ Can be used with 60 LED's per meter

## LED 12V 65mm Downlight



- 24 LED down light mounted on a SAA finish bevel
- Rated at 1.65W per down light
- Available in 2 colour temperatures
  - 3000K - Warm light
  - 6000K - Cool light
- 40000 Hr LED Life, equivalent to over 10 years at 8 hours per day
- Comes with 1.5M of cable and plug.
- Supplied with 1 year guarantee

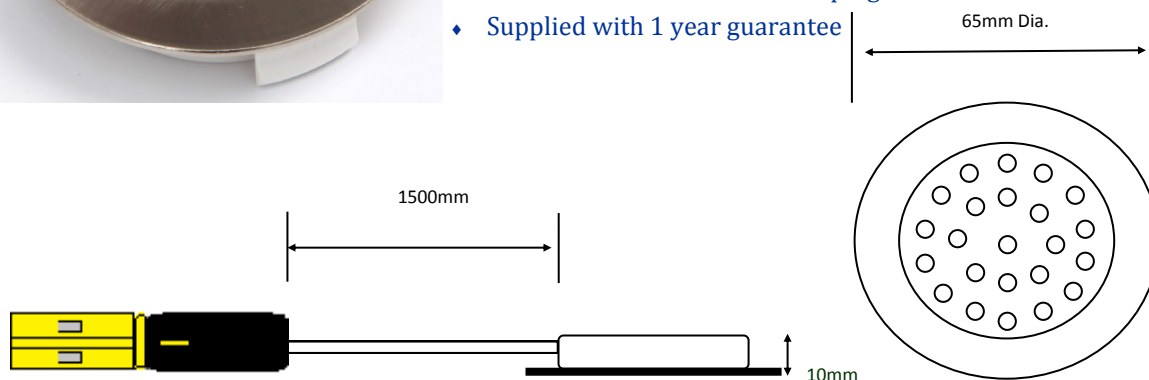

## LED 12V 53mm 3W Spotlight



- 3W spot light mounted on a polished aluminium casing
- The LED is available in colours:-
  - 3000K - Warm Light
  - 4000K - Day Light
  - 6000K - Cool Light
- The unit is able to swivel up to 30° in either direction
- 3W LED giving a high lumin Output.
- The spotlight has a 60° LED for good light intensity
- Powered by 12V DC and can used in conjunction with the plug & play system
- In line micro clip connector for easy maintenance
- 2 spring clips attached for easy installation
- 40,000 hour LED Lifespan
- From plug to the spotlight is 500mm
- 1 Year Guarantee

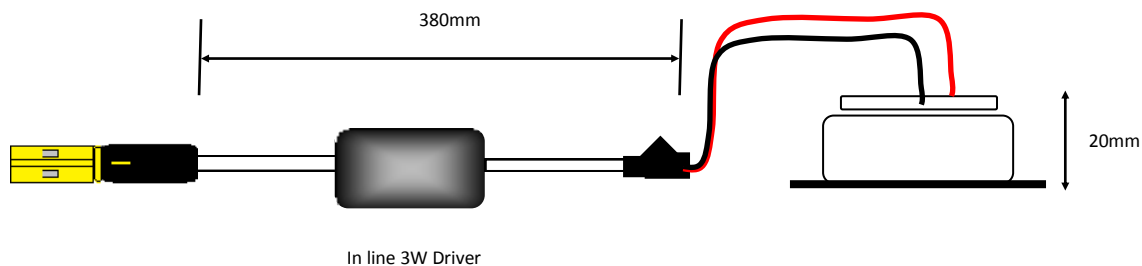

---

## In Line Manual Plug & Play Dimmer / Controller

---

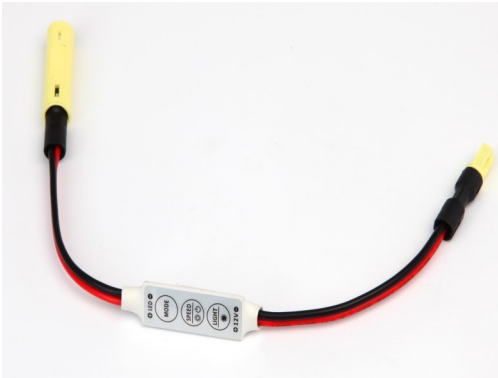

- ◆ In line single colour dimmer / controller
- ◆ Enables the user to change the LED strobe speed and brightness settings on LED strips
- ◆ Memory function which remembers its settings after the power has been turned off.
- ◆ 5 strobe modes
- ◆ Max Output Current 7A
- ◆ Also available for RGB LED's

---

## Remote Control Plug & Play Dimmer / Controller

---



- ◆ In line RF dimmer / controller unit for single colour LED's
- ◆ Comes with RF remote control
- ◆ Can be used with 60 LED's per meter
- ◆ 8 Brightness levels
- ◆ 8 strobe modes
- ◆ 6 Speed Settings
- ◆ Also available for RGB LED's

---

## 8mm Snap Connector - 140mm Tail—8mm Snap Connector

---

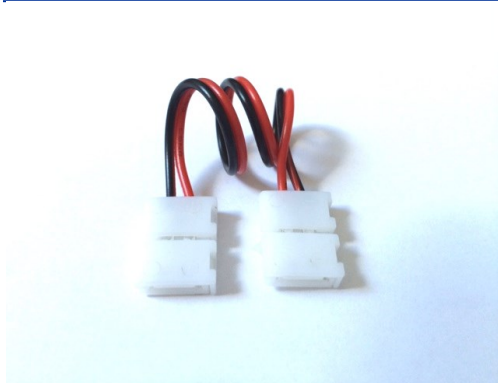

- ◆ Just simply insert the LED under the contacts and close the lid
- ◆ Enables 2 LED strips to be connected together
- ◆ Allows for multiple angles and shapes
- ◆ Able to handle up to 5 amps per connector
- ◆ Can be used with 60 LED's per meter

---

## 2000mm Aluminium Flat / Corner LED Channel

---



- ◆ Available in 2000mm lengths
- ◆ 3 different diffusers - Opal, Frosted or Clear
- ◆ Optional endplates to enhance its appearance
- ◆ Can be used with rear mounting brackets for easy installation
- ◆ We are able to offer a ready made to measure option with end-plates and professionally installed LED's with the users choice of diffuser. Please ask for details.



## Installation Examples

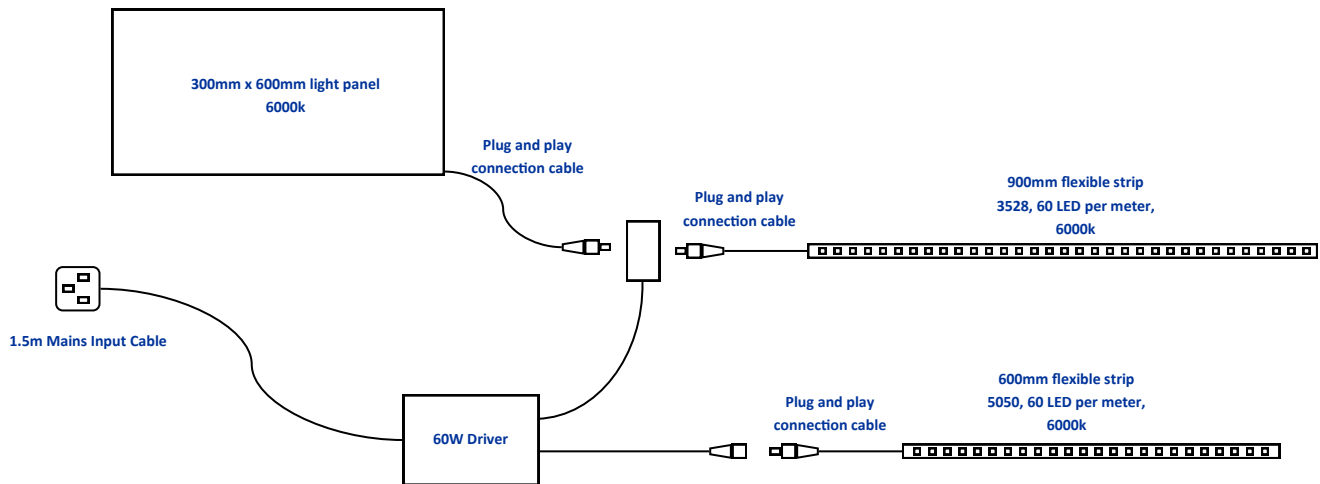

For the above installation you would need to order:

- 3 x Plug and play connection cable
- 1 x 60 watt driver with 1.5m input cable, fitted with 6 way distribution box and single output cable.
- 1 x 900mm x 300mm light panel, 6000k.
- 1 x 900mm long flexible strip, 3528, 60 led per meter, 6000k.
- 1 x 600mm long flexible strip, 5050, 60 led per meter, 6000k.

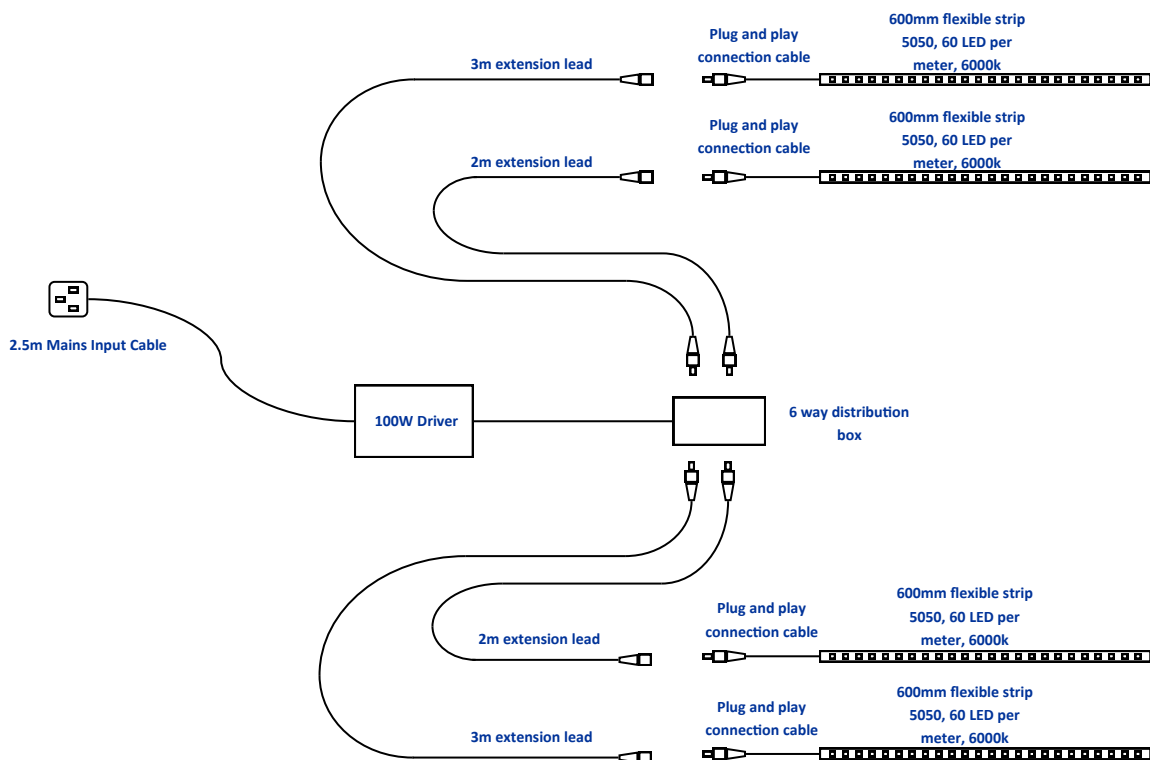

For the above installation you would need to order:

- 4 x Plug and play connection cable
- 1 x 100 watt driver with 2.5m input cable, fitted with 6 way distribution box.
- 4 x 600mm long flexible strip, 5050, 60 led per meter, 6000k.
- 2 x 2m long extension cable.
- 2 x 3m long extension cable.